



TRUSTED SOLUTIONS AND INNOVATION

VARIABLE PRECISION SERIES



RELY ON
ANCHOR DANLY
FOR...

- ◆ QUICK DELIVERY
- ◆ CONSISTENT QUALITY
- ◆ TOTAL CUSTOMER SUPPORT
- ◆ QUICK QUOTES ON SPECIALS

VARIABLE PRECISION SERIES PUNCHES

FAST, FLEXIBLE AND FULL SERVICE PUNCH SUPPLIER

Anchor Danly manufactures a full line of standard and custom punch products, die buttons and retainers to high quality standards giving you the reliability and dependable performance you expect. Punches have always been a significant product foundation of our business. Through the years, we have developed expertise in manufacturing a wide range of them.

This catalog features the Anchor Danly Punchrite Variable Precision Punch Series in standard shapes. Designed and manufactured for longer production runs, Anchor Danly Punchrite punches meet or exceed ANSI standards. Products are manufactured to exacting tolerances to assure interchangeability. Each component is made of quality heat treated tool steel. Whether your application is the most simple design or the most complex application, rely on Anchor Danly Punchrite to fit your needs.

Anchor Danly is a leading manufacturer of die sets and die applications, with various locations. With years of experience in the industry, we have gained an in-depth knowledge of metal stamping which we share with our customers.

Punches, Die Buttons and Components

- Full line of standard shapes plus custom products
- Ready availability and fast service
- Technical assistance
- Complies with ANSI standards
- High strength tool steels
- Assured interchangeability
- Consistent craftsmanship

For Standard or Special Punches











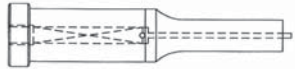

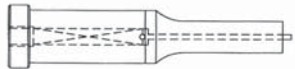







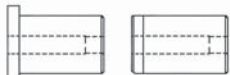

In addition to standard and coded shapes, **ANCHOR DANLY** offers special punches, die buttons and other components custom-made to your specifications. Almost any shape can be put on a standard shank. Using **ANCHOR DANLY** components means cost-effective, fast and precise interchangeability.

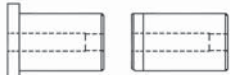
To enable us to effectively quote your special punch needs, please provide complete specifications and prints where possible.

***FOR FAST QUOTES, DEPENDABLE DELIVERY AND TECHNICAL ASSISTANCE
FOR STANDARDS AND SPECIALS, RELY ON ANCHOR DANLY.***

Variable Precision Series

PAGE NUMBER

Perforating Ejector Punches – Round	2		
Perforating Ejector Punches – Shapes	3		
Perforating Punches – Round	4		
Perforating Punches – Shapes	5		
Pilot Punches	6		
“A” Type Pilot Punches	7		
Press Fit Die Buttons – Round	8		
Press Fit Die Buttons – Shapes	9		
Ejector Punch Blanks	10		
Blank & Straight Punches	11		
Stripper Guides	12		
Locking Devices	13		

Perforating Ejector Punches



Round

Concentricity: Point to Shank (P:D)
.0003 T.I.R. (Max.)

* (.125 WHEN D = .1875 DIA.)
** (.03 FOR VP2, VP3)

How to order:
Please specify: Quantity, catalog number, length code, point diameter and material.
See ordering examples.

NOTE: If material is not specified, M2 will be provided.

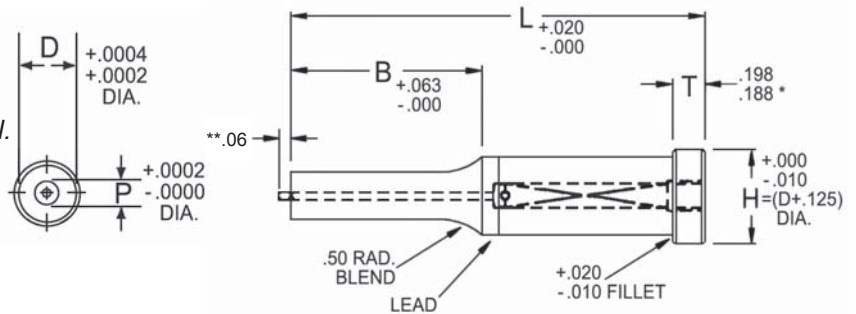

CKV (ROUND)

Shaded areas represent standard products.
Others available upon request.

Shank Dia.	Catalog Number	Point Length	Point Range		Overall Length L & Code												Ejector Group
			P Min.	P Max.	1.25	1.50	1.75	2.00	2.25	2.50	2.75	3.00	3.25	3.50	3.75	4.00	
.1875	CKV18	0.50	0.062	0.1874	1252	1502	1752	2002	2252	2502	-	-	-	-	-	-	VP2
.2500	CKV25		0.093	0.2499	1252	1502	1752	2002	2252	2502	2752	3002	-	-	-	-	VP3
.3125	CKV31		0.125	0.3124	1252	1502	1752	2002	2252	2502	2752	3002	-	-	-	-	VP4
.3750	CKV37		0.187	0.3749	1252	1502	1752	2002	2252	2502	2752	3002	3252	3502	-	-	VP6
.1875	CKV18	0.75	0.062	0.1874	-	1503	1753	2003	2253	2503	-	-	-	-	-	-	VP2
.2500	CKV25		0.093	0.2499	-	1503	1753	2003	2253	2503	2753	3003	-	-	-	-	VP3
.3125	CKV31		0.125	0.3124	-	1503	1753	2003	2253	2503	2753	3003	-	-	-	-	VP4
.3750	CKV37		0.187	0.3749	-	1503	1753	2003	2253	2503	2753	3003	3253	3503	-	-	VP6
.4375	CKV43		0.187	0.4374	-	1503	1753	2003	2253	2503	2753	3003	3253	3503	-	-	VP6
.5000	CLV50		0.225	0.4999	-	1503	1753	2003	2253	2503	2753	3003	3253	3503	3753	4003	VP6
.6250	CKV62		0.310	0.6249	-	1503	1753	2003	2253	2503	2753	3003	3253	3503	3753	4003	VP9
.7500	CKV75		0.390	0.7499	-	1503	1753	2003	2253	2503	2753	3003	3253	3503	3753	4003	VP9
1.0000	CKV100	0.485	0.9999	-	1503	1753	2003	2253	2503	2753	3003	3253	3503	3753	4003	VP9	
.1875	CKV18	1.00	0.062	0.1874	-	-	1754	2004	2254	2504	-	-	-	-	-	-	VP2
.2500	CKV25		0.093	0.2499	-	-	1754	2004	2254	2504	2754	3004	-	-	-	-	VP3
.3125	CKV31		0.125	0.3124	-	-	1754	2004	2254	2504	2754	3004	-	-	-	-	VP4
.3750	CKV37		0.187	0.3749	-	-	1754	2004	2254	2504	2754	3004	3254	3504	-	-	VP6
.4375	CKV43		0.187	0.4374	-	-	1754	2004	2254	2504	2754	3004	3254	3504	-	-	VP6
.5000	CKV50		0.225	0.4999	-	-	1754	2004	2254	2504	2754	3004	3254	3504	3754	4004	VP6
.6250	CKV62		0.310	0.6249	-	-	1754	2004	2254	2504	2754	3004	3254	3504	3754	4004	VP9
.7500	CKV75		0.390	0.7499	-	-	1754	2004	2254	2504	2754	3004	3254	3504	3754	4004	VP9
1.0000	CKV100	0.485	0.9999	-	-	1754	2004	2254	2504	2754	3004	3254	3504	3754	4004	VP9	
.2500	CKV25	1.25	0.093	0.2499	-	-	-	2005	2255	2505	2755	3005	-	-	-	-	VP3
.3125	CKV31		0.125	0.3124	-	-	-	2005	2255	2505	2755	3005	-	-	-	-	VP4
.3750	CKV37		0.187	0.3749	-	-	-	2005	2255	2505	2755	3005	3255	3505	-	-	VP6
.4375	CKV43		0.187	0.4374	-	-	-	2005	2255	2505	2755	3005	3255	3505	-	-	VP6
.5000	CKV50		0.225	0.4999	-	-	-	2005	2255	2505	2755	3005	3255	3505	3755	4005	VP6
.6250	CKV62		0.310	0.6249	-	-	-	2005	2255	2505	2755	3005	3255	3505	3755	4005	VP9
.7500	CKV75		0.390	0.7499	-	-	-	2005	2255	2505	2755	3005	3255	3505	3755	4005	VP9
1.0000	CKV100		0.485	0.9999	-	-	-	2005	2255	2505	2755	3005	3255	3505	3755	4005	VP9
.3125	CKV31	1.50	0.125	0.3124	-	-	-	-	2256	2506	2756	3006	-	-	-	-	VP4
.3750	CKV37		0.187	0.3749	-	-	-	-	2256	2506	2756	3006	3256	3506	-	-	VP6
.4375	CKV43		0.187	0.4374	-	-	-	-	2256	2506	2756	3006	3256	3506	-	-	VP6
.5000	CKV50		0.225	0.4999	-	-	-	-	2256	2506	2756	3006	3256	3506	3756	4006	VP6
.6250	CKV62		0.310	0.6249	-	-	-	-	2256	2506	2756	3006	3256	3506	3756	4006	VP9
.7500	CKV75		0.390	0.7499	-	-	-	-	2256	2506	2756	3006	3256	3506	3756	4006	VP9
1.0000	CKV100	0.485	0.9999	-	-	-	-	2256	2506	2756	3006	3256	3506	3756	4006	VP9	

EXAMPLE: 5 CKV18 - 2004 P .100 PM4

NOTE: Refer to the Miscellaneous section for ejector data.



Oblong and Rectangle

Concentricity: Point to Shank (P:D)
.0003 T.I.R. (Max.)

$$G = \sqrt{W^2 + P^2}$$

* (.125 WHEN D = .1875 DIA.)
** (.03 FOR VP2, VP3)

How to order:

Please specify: Quantity, catalog number, length code, point dimensions, material and, if desired, Standard or Custom Locking Device.*

See ordering examples.

NOTE: If material is not specified, M2 will be provided.

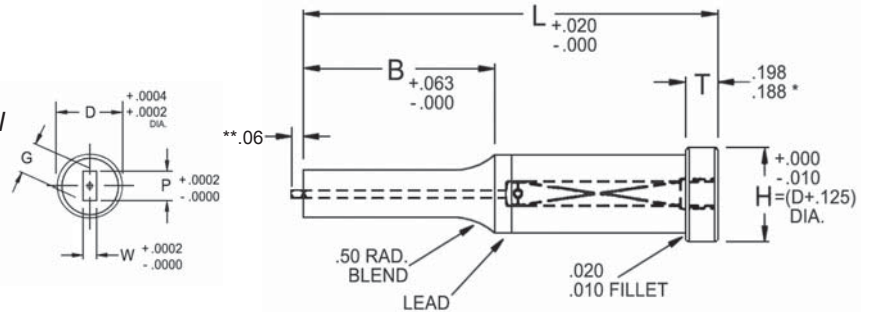

OKV (OBLONG)



RKV (RECTANGLE, INCLUDES SQUARE)

Shaded areas represent standard products.
Others available upon request.

Shank Dia.	Catalog Number	Point Length	Point Range		Overall Length L & Code												Ejector Group
			P/G Max.	W Min.	1.25	1.50	1.75	2.00	2.25	2.50	2.75	3.00	3.25	3.50	3.75	4.00	
.1875	_KV18	0.50	0.1874	0.062	1252	1502	1752	2002	2252	2502	-	-	-	-	-	-	VP2
.2500	_KV25		0.2499	0.093	1252	1502	1752	2002	2252	2502	2752	3002	-	-	-	-	VP3
.3125	_KV31		0.3124	0.125	1252	1502	1752	2002	2252	2502	2752	3002	-	-	-	-	VP4
.3750	_KV37		0.3749	0.187	1252	1502	1752	2002	2252	2502	2752	3002	3252	3502	-	-	VP6
.1875	_KV18	0.75	0.1874	0.062	-	1503	1753	2003	2253	2503	-	-	-	-	-	-	VP2
.2500	_KV25		0.2499	0.093	-	1503	1753	2003	2253	2503	2753	3003	-	-	-	-	VP3
.3125	_KV31		0.3124	0.125	-	1503	1753	2003	2253	2503	2753	3003	-	-	-	-	VP4
.3750	_KV37		0.3749	0.187	-	1503	1753	2003	2253	2503	2753	3003	3253	3503	-	-	VP6
.4375	_KV43		0.4374	0.187	-	1503	1753	2003	2253	2503	2753	3003	3253	3503	-	-	VP6
.5000	_LV50		0.4999	0.250	-	1503	1753	2003	2253	2503	2753	3003	3253	3503	3753	4003	VP6
.6250	_KV62		0.6249	0.282	-	1503	1753	2003	2253	2503	2753	3003	3253	3503	3753	4003	VP9
.7500	_KV75		0.7499	0.312	-	1503	1753	2003	2253	2503	2753	3003	3253	3503	3753	4003	VP9
1.0000	_KV100		0.9999	0.375	-	1503	1753	2003	2253	2503	2753	3003	3253	3503	3753	4003	VP9
.1875	_KV18	1.00	0.1874	0.062	-	-	1754	2004	2254	2504	-	-	-	-	-	-	VP2
.2500	_KV25		0.2499	0.093	-	-	1754	2004	2254	2504	2754	3004	-	-	-	-	VP3
.3125	_KV31		0.3124	0.125	-	-	1754	2004	2254	2504	2754	3004	-	-	-	-	VP4
.3750	_KV37		0.3749	0.187	-	-	1754	2004	2254	2504	2754	3004	3254	3504	-	-	VP6
.4375	_KV43		0.4374	0.187	-	-	1754	2004	2254	2504	2754	3004	3254	3504	-	-	VP6
.5000	_KV50		0.4999	0.250	-	-	1754	2004	2254	2504	2754	3004	3254	3504	3754	4004	VP6
.6250	_KV62		0.6249	0.282	-	-	1754	2004	2254	2504	2754	3004	3254	3504	3754	4004	VP9
.7500	_KV75		0.7499	0.312	-	-	1754	2004	2254	2504	2754	3004	3254	3504	3754	4004	VP9
1.0000	_KV100		0.9999	0.375	-	-	1754	2004	2254	2504	2754	3004	3254	3504	3754	4004	VP9
.2500	_KV25	1.25	0.2499	0.093	-	-	-	2005	2255	2505	2755	3005	-	-	-	-	VP3
.3125	_KV31		0.3124	0.125	-	-	-	2005	2255	2505	2755	3005	-	-	-	-	VP4
.3750	_KV37		0.3749	0.187	-	-	-	2005	2255	2505	2755	3005	3255	3505	-	-	VP6
.4375	_KV43		0.4374	0.187	-	-	-	2005	2255	2505	2755	3005	3255	3505	-	-	VP6
.5000	_KV50		0.4999	0.250	-	-	-	2005	2255	2505	2755	3005	3255	3505	3755	4005	VP6
.6250	_KV62		0.6249	0.282	-	-	-	2005	2255	2505	2755	3005	3255	3505	3755	4005	VP9
.7500	_KV75		0.7499	0.312	-	-	-	2005	2255	2505	2755	3005	3255	3505	3755	4005	VP9
1.0000	_KV100		0.9999	0.375	-	-	-	2005	2255	2505	2755	3005	3255	3505	3755	4005	VP9
.3125	_KV31		1.50	0.3124	0.125	-	-	-	-	2256	2506	2756	3006	-	-	-	-
.3750	_KV37	0.3749		0.187	-	-	-	-	2256	2506	2756	3006	3256	3506	-	-	VP6
.4375	_KV43	0.4374		0.187	-	-	-	-	2256	2506	2756	3006	3256	3506	-	-	VP6
.5000	_KV50	0.4999		0.250	-	-	-	-	2256	2506	2756	3006	3256	3506	3756	4006	VP6
.6250	_KV62	0.6249		0.282	-	-	-	-	2256	2506	2756	3006	3256	3506	3756	4006	VP9
.7500	_KV75	0.7499		0.312	-	-	-	-	2256	2506	2756	3006	3256	3506	3756	4006	VP9
1.0000	_KV100	0.9999	0.375	-	-	-	-	2256	2506	2756	3006	3256	3506	3756	4006	VP9	

EXAMPLE: 5 OKV25 - 2004 P .100 PM4 SKF

* Refer to page 13 for Locking Device information.

NOTE: Refer to the Miscellaneous section for ejector data.

Perforating Punches



Round

Concentricity: Point to Shank (P:D)
.0003 T.I.R. (Max.)

How to order:

Please specify: Quantity, catalog number, length code, point diameter and material.

See ordering examples.

NOTE: If material is not specified, M2 will be provided.

$$G = \sqrt{W^2 + P^2}$$

* (.125 WHEN D = .1250 DIA.
OR .1875

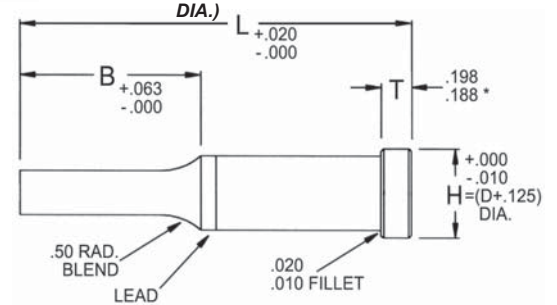
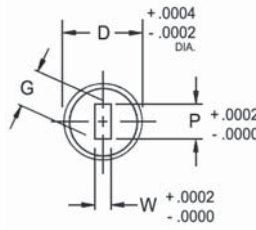

CPV (ROUND)

Shaded areas represent standard products.
Others available upon request.

Shank Dia.	Catalog Number	Point Length	Point Range		Overall Length L & Code											
					P Min.	P Max.	1.25	1.50	1.75	2.00	2.25	2.50	2.75	3.00	3.25	3.50
.1250	CPV12	0.50	0.031	0.1249	1252	1502	1752	2002	2252	2502	-	-	-	-	-	-
.1875	CPV18		0.062	0.1874	1252	1502	1752	2002	2252	2502	2752	-	-	-	-	-
.2500	CPV25		0.093	0.2499	1252	1502	1752	2002	2252	2502	2752	3002	-	-	-	-
.3125	CPV31		0.125	0.3124	1252	1502	1752	2002	2252	2502	2752	3002	-	-	-	-
.3750	CPV37		0.187	0.3749	1252	1502	1752	2002	2252	2502	2752	3002	3252	3502	-	-
.1250	CPV12	0.75	0.062	0.1249	-	1503	1753	2003	2253	2503	-	-	-	-	-	-
.1875	CPV18		0.062	0.1874	-	1503	1753	2003	2253	2503	2753	-	-	-	-	-
.2500	CPV25		0.093	0.2499	-	1503	1753	2003	2253	2503	2753	3003	-	-	-	-
.3125	CPV31		0.125	0.3124	-	1503	1753	2003	2253	2503	2753	3003	-	-	-	-
.3750	CPV37		0.187	0.3749	-	1503	1753	2003	2253	2503	2753	3003	3253	3503	-	-
.4375	CPV43		0.187	0.4374	-	1503	1753	2003	2253	2503	2753	3003	3253	3503	-	-
.5000	CPV50		0.225	0.4999	-	1503	1753	2003	2253	2503	2753	3003	3253	3503	3753	4003
.6250	CPV62		0.310	0.6249	-	1503	1753	2003	2253	2503	2753	3003	3253	3503	3753	4003
.7500	CPV75		0.390	0.7499	-	1503	1753	2003	2253	2503	2753	3003	3253	3503	3753	4003
1.0000	CPV100		0.485	0.9999	-	1503	1753	2003	2253	2503	2753	3003	3253	3503	3753	4003
.1250	CPV12	1.00	0.062	0.1249	-	-	1754	2004	2254	2504	-	-	-	-	-	-
.1875	CPV18		0.062	0.1874	-	-	1754	2004	2254	2504	2754	-	-	-	-	-
.2500	CPV25		0.093	0.2499	-	-	1754	2004	2254	2504	2754	3004	-	-	-	-
.3125	CPV31		0.125	0.3124	-	-	1754	2004	2254	2504	2754	3004	-	-	-	-
.3750	CPV37		0.187	0.3749	-	-	1754	2004	2254	2504	2754	3004	3254	3504	-	-
.4375	CPV43		0.187	0.4374	-	-	1754	2004	2254	2504	2754	3004	3254	3504	-	-
.5000	CPV50		0.225	0.4999	-	-	1754	2004	2254	2504	2754	3004	3254	3504	3754	4004
.6250	CPV62		0.310	0.6249	-	-	1754	2004	2254	2504	2754	3004	3254	3504	3754	4004
.7500	CPV75		0.390	0.7499	-	-	1754	2004	2254	2504	2754	3004	3254	3504	3754	4004
1.0000	CPV100		0.485	0.9999	-	-	1754	2004	2254	2504	2754	3004	3254	3504	3754	4004
.1250	CPV12	1.25	0.093	0.1249	-	-	-	2005	2255	2505	-	-	-	-	-	-
.1875	CPV18		0.093	0.1874	-	-	-	2005	2255	2505	2755	-	-	-	-	-
.2500	CPV25		0.093	0.2499	-	-	-	2005	2255	2505	2755	3005	-	-	-	-
.3125	CPV31		0.125	0.3124	-	-	-	2005	2255	2505	2755	3005	-	-	-	-
.3750	CPV37		0.187	0.3749	-	-	-	2005	2255	2505	2755	3005	3255	3505	-	-
.4375	CPV43		0.187	0.4374	-	-	-	2005	2255	2505	2755	3005	3255	3505	-	-
.5000	CPV50		0.225	0.4999	-	-	-	2005	2255	2505	2755	3005	3255	3505	3755	4005
.6250	CPV62		0.310	0.6249	-	-	-	2005	2255	2505	2755	3005	3255	3505	3755	4005
.7500	CPV75		0.390	0.7499	-	-	-	2005	2255	2505	2755	3005	3255	3505	3755	4005
1.0000	CPV100		0.485	0.9999	-	-	-	2005	2255	2505	2755	3005	3255	3505	3755	4005
.1875	CPV18	1.50	0.125	0.1874	-	-	-	-	2256	2506	2756	-	-	-	-	-
.2500	CPV25		0.125	0.2499	-	-	-	-	2256	2506	2756	3006	-	-	-	-
.3125	CPV31		0.125	0.3124	-	-	-	-	2256	2506	2756	3006	-	-	-	-
.3750	CPV37		0.187	0.3749	-	-	-	-	2256	2506	2756	3006	3256	3506	-	-
.4375	CPV43		0.187	0.4374	-	-	-	-	2256	2506	2756	3006	3256	3506	-	-
.5000	CPV50		0.225	0.4999	-	-	-	-	2256	2506	2756	3006	3256	3506	3756	4006
.6250	CPV62		0.310	0.6249	-	-	-	-	2256	2506	2756	3006	3256	3506	3756	4006
.7500	CPV75		0.390	0.7499	-	-	-	-	2256	2506	2756	3006	3256	3506	3756	4006
1.0000	CPV100		0.485	0.9999	-	-	-	-	2256	2506	2756	3006	3256	3506	3756	4006

EXAMPLE: 8 CPV37 - 2255 P .155 PM4

Oblong and Rectangle

Concentricity: Point to Shank (P:D):
.003 T.I.R. (Max.)

How to order:

Please specify: Quantity, catalog number, length code, point dimensions and material.

See ordering examples.

NOTE: If material is not specified, M2 will be provided.

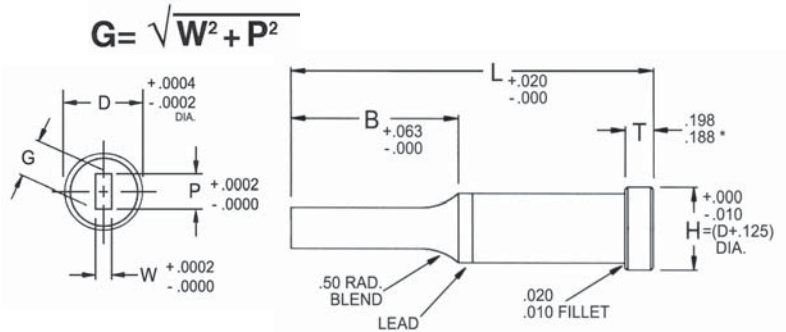

OPV (OBLONG)



RPV (RECTANGLE, INCLUDES SQUARE)

Shaded areas represent standard products.
Others available upon request.

Shank Dia.	Catalog Number	Point Length	Point Range		Overall Length L & Code											
			P/G Max.	W Min.	1.25	1.50	1.75	2.00	2.25	2.50	2.75	3.00	3.25	3.50	3.75	4.00
.1250	_PV12	0.50	0.1249	0.062	1252	1502	1752	2002	2252	2502	-	-	-	-	-	-
.1875	_PV18		0.1874	0.062	1252	1502	1752	2002	2252	2502	2752	-	-	-	-	-
.2500	_PV25		0.2499	0.062	1252	1502	1752	2002	2252	2502	2752	3002	-	-	-	-
.3125	_PV31		0.3124	0.093	1252	1502	1752	2002	2252	2502	2752	3002	-	-	-	-
.3750	_PV37		0.3749	0.125	1252	1502	1752	2002	2252	2502	2752	3002	3252	3502	-	-
.1250	_PV12	0.75	0.1249	0.062	-	1503	1753	2003	2253	2503	-	-	-	-	-	-
.1875	_PV18		0.1874	0.062	-	1503	1753	2003	2253	2503	2753	-	-	-	-	-
.2500	_PV25		0.2499	0.062	-	1503	1753	2003	2253	2503	2753	3003	-	-	-	-
.3125	_PV31		0.3124	0.093	-	1503	1753	2003	2253	2503	2753	3003	-	-	-	-
.3750	_PV37		0.3749	0.125	-	1503	1753	2003	2253	2503	2753	3003	3253	3503	-	-
.4375	_PV43		0.4374	0.187	-	1503	1753	2003	2253	2503	2753	3003	3253	3503	-	-
.5000	_PV50		0.4999	0.187	-	1503	1753	2003	2253	2503	2753	3003	3253	3503	3753	4003
.6250	_PV62		0.6249	0.250	-	1503	1753	2003	2253	2503	2753	3003	3253	3503	3753	4003
.7500	_PV75		0.7499	0.312	-	1503	1753	2003	2253	2503	2753	3003	3253	3503	3753	4003
1.0000	_PV100		0.9999	0.375	-	1503	1753	2003	2253	2503	2753	3003	3253	3503	3753	4003
.1250	_PV12	1.00	0.1249	0.062	-	-	1754	2004	2254	2504	-	-	-	-	-	-
.1875	_PV18		0.1874	0.062	-	-	1754	2004	2254	2504	2754	-	-	-	-	-
.2500	_PV25		0.2499	0.062	-	-	1754	2004	2254	2504	2754	3004	-	-	-	-
.3125	_PV31		0.3124	0.093	-	-	1754	2004	2254	2504	2754	3004	-	-	-	-
.3750	_PV37		0.3749	0.125	-	-	1754	2004	2254	2504	2754	3004	3254	3504	-	-
.4375	_PV43		0.4374	0.187	-	-	1754	2004	2254	2504	2754	3004	3254	3504	-	-
.5000	_PV50		0.4999	0.187	-	-	1754	2004	2254	2504	2754	3004	3254	3504	3754	4004
.6250	_PV62		0.6249	0.250	-	-	1754	2004	2254	2504	2754	3004	3254	3504	3754	4004
.7500	_PV75		0.7499	0.312	-	-	1754	2004	2254	2504	2754	3004	3254	3504	3754	4004
1.0000	_PV100		0.9999	0.375	-	-	1754	2004	2254	2504	2754	3004	3254	3504	3754	4004
.1250	_PV12	1.25	0.1249	0.093	-	-	-	2005	2255	2505	-	-	-	-	-	-
.1875	_PV18		0.1874	0.093	-	-	-	2005	2255	2505	2755	-	-	-	-	-
.2500	_PV25		0.2499	0.093	-	-	-	2005	2255	2505	2755	3005	-	-	-	-
.3125	_PV31		0.3124	0.093	-	-	-	2005	2255	2505	2755	3005	-	-	-	-
.3750	_PV37		0.3749	0.125	-	-	-	2005	2255	2505	2755	3005	3255	3505	-	-
.4375	_PV43		0.4374	0.187	-	-	-	2005	2255	2505	2755	3005	3255	3505	-	-
.5000	_PV50		0.4999	0.187	-	-	-	2005	2255	2505	2755	3005	3255	3505	3755	4005
.6250	_PV62		0.6249	0.250	-	-	-	2005	2255	2505	2755	3005	3255	3505	3755	4005
.7500	_PV75		0.7499	0.312	-	-	-	2005	2255	2505	2755	3005	3255	3505	3755	4005
1.0000	_PV100		0.9999	0.375	-	-	-	2005	2255	2505	2755	3005	3255	3505	3755	4005
.1875	_PV18	1.50	0.1874	0.125	-	-	-	-	2256	2506	2756	-	-	-	-	-
.2500	_PV25		0.2499	0.125	-	-	-	-	2256	2506	2756	3006	-	-	-	-
.3125	_PV31		0.3124	0.125	-	-	-	-	2256	2506	2756	3006	-	-	-	-
.3750	_PV37		0.3749	0.125	-	-	-	-	2256	2506	2756	3006	3256	3506	-	-
.4375	_PV43		0.4374	0.187	-	-	-	-	2256	2506	2756	3006	3256	3506	-	-
.5000	_PV50		0.4999	0.187	-	-	-	-	2256	2506	2756	3006	3256	3506	3756	4006
.6250	_PV62		0.6249	0.250	-	-	-	-	2256	2506	2756	3006	3256	3506	3756	4006
.7500	_PV75		0.7499	0.312	-	-	-	-	2256	2506	2756	3006	3256	3506	3756	4006
1.0000	_PV100	0.9999	0.375	-	-	-	-	2256	2506	2756	3006	3256	3506	3756	4006	

EXAMPLE: 8 OPV25 - 2255 P .155 W .130 PM4 SKF

* Refer to page 13 for Locking Device information.

Pilot Punches



Standard

Concentricity: Point to Shank (P:D)
 .0003 T.I.R. (Max.)

How to order:

Please specify: Quantity, catalog number, length code, point diameter and material.

See ordering examples.

NOTE: If material is not specified, M2 will be provided.

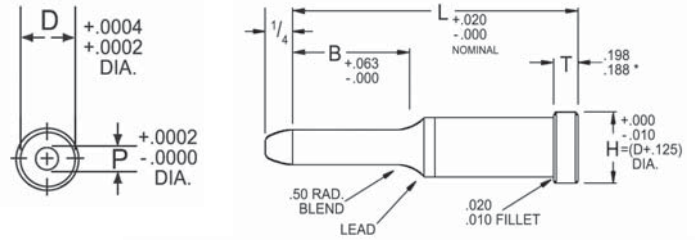

PPV

Shaded areas represent standard products.
 Others available upon request.

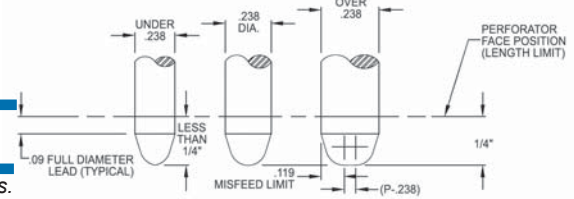

Shank Dia.	Catalog Number	Point Length	Point Range		Nominal Length L & Code											
			P Min.	P Max.	1.25	1.50	1.75	2.00	2.25	2.50	2.75	3.00	3.25	3.50	3.75	4.00
.1250	PPV12	0.50	0.061	0.1250	1252	1502	1752	2002	2252	2502	-	-	-	-	-	-
.1875	PPV18		0.061	0.1875	1252	1502	1752	2002	2252	2502	2752	-	-	-	-	-
.2500	PPV25		0.061	0.2500	1252	1502	1752	2002	2252	2502	2752	3002	-	-	-	-
.3125	PPV31		0.092	0.3125	1252	1502	1752	2002	2252	2502	2752	3002	-	-	-	-
.3750	PPV37		0.124	0.3750	1252	1502	1752	2002	2252	2502	2752	3002	3252	3502	-	-
.1250	PPV12	0.75	0.061	0.1250	-	1503	1753	2003	2253	2503	-	-	-	-	-	-
.1875	PPV18		0.061	0.1875	-	1503	1753	2003	2253	2503	2753	-	-	-	-	-
.2500	PPV25		0.061	0.2500	-	1503	1753	2003	2253	2503	2753	3003	-	-	-	-
.3125	PPV31		0.092	0.3125	-	1503	1753	2003	2253	2503	2753	3003	-	-	-	-
.3750	PPV37		0.124	0.3750	-	1503	1753	2003	2253	2503	2753	3003	3253	3503	-	-
.4375	PPV43		0.186	0.4375	-	1503	1753	2003	2253	2503	2753	3003	3253	3503	-	-
.5000	PPV50		0.224	0.5000	-	1503	1753	2003	2253	2503	2753	3003	3253	3503	3753	4003
.6250	PPV62		0.309	0.6250	-	1503	1753	2003	2253	2503	2753	3003	3253	3503	3753	4003
.7500	PPV75		0.389	0.7500	-	1503	1753	2003	2253	2503	2753	3003	3253	3503	3753	4003
1.0000	PPV100		0.484	1.0000	-	1503	1753	2003	2253	2503	2753	3003	3253	3503	3753	4003
.1250	PPV12	1.00	0.061	0.1250	-	-	1754	2004	2254	2504	-	-	-	-	-	-
.1875	PPV18		0.061	0.1875	-	-	1754	2004	2254	2504	2754	-	-	-	-	-
.2500	PPV25		0.061	0.2500	-	-	1754	2004	2254	2504	2754	3004	-	-	-	-
.3125	PPV31		0.092	0.3125	-	-	1754	2004	2254	2504	2754	3004	-	-	-	-
.3750	PPV37		0.124	0.3750	-	-	1754	2004	2254	2504	2754	3004	3254	3504	-	-
.4375	PPV43		0.186	0.4375	-	-	1754	2004	2254	2504	2754	3004	3254	3504	-	-
.5000	PPV50		0.224	0.5000	-	-	1754	2004	2254	2504	2754	3004	3254	3504	3754	4004
.6250	PPV62		0.309	0.6250	-	-	1754	2004	2254	2504	2754	3004	3254	3504	3754	4004
.7500	PPV75		0.389	0.7500	-	-	1754	2004	2254	2504	2754	3004	3254	3504	3754	4004
1.0000	PPV100		0.484	1.0000	-	-	1754	2004	2254	2504	2754	3004	3254	3504	3754	4004
.1250	PPV12	1.25	0.092	0.1250	-	-	-	2005	2255	2505	-	-	-	-	-	-
.1875	PPV18		0.092	0.1875	-	-	-	2005	2255	2505	2755	-	-	-	-	-
.2500	PPV25		0.092	0.2500	-	-	-	2005	2255	2505	2755	3005	-	-	-	-
.3125	PPV31		0.124	0.3125	-	-	-	2005	2255	2505	2755	3005	-	-	-	-
.3750	PPV37		0.124	0.3750	-	-	-	2005	2255	2505	2755	3005	3255	3505	-	-
.4375	PPV43		0.186	0.4375	-	-	-	2005	2255	2505	2755	3005	3255	3505	-	-
.5000	PPV50		0.224	0.5000	-	-	-	2005	2255	2505	2755	3005	3255	3505	3755	4005
.6250	PPV62		0.309	0.6250	-	-	-	2005	2255	2505	2755	3005	3255	3505	3755	4005
.7500	PPV75		0.389	0.7500	-	-	-	2005	2255	2505	2755	3005	3255	3505	3755	4005
1.0000	PPV100		0.484	1.0000	-	-	-	2005	2255	2505	2755	3005	3255	3505	3755	4005
.1875	PPV18	1.50	0.124	0.1875	-	-	-	-	2256	2506	2756	-	-	-	-	-
.2500	PPV25		0.124	0.2500	-	-	-	-	2256	2506	2756	3006	-	-	-	-
.3125	PPV31		0.124	0.3125	-	-	-	-	2256	2506	2756	3006	-	-	-	-
.3750	PPV37		0.124	0.3750	-	-	-	-	2256	2506	2756	3006	3256	3506	-	-
.4375	PPV43		0.186	0.4375	-	-	-	-	2256	2506	2756	3006	3256	3506	-	-
.5000	PPV50		0.224	0.5000	-	-	-	-	2256	2506	2756	3006	3256	3506	3756	4006
.6250	PPV62		0.309	0.6250	-	-	-	-	2256	2506	2756	3006	3256	3506	3756	4006
.7500	PPV75		0.389	0.7500	-	-	-	-	2256	2506	2756	3006	3256	3506	3756	4006
1.0000	PPV100	0.484	1.0000	-	-	-	-	2256	2506	2756	3006	3256	3506	3756	4006	

EXAMPLE: 15 PPV62 - 4006 P .509 PM4

“A” Type Pilot

Concentricity: Point to Shank (P:D)
 .0003 T.I.R. (Max.)

How to order:

Please specify: Quantity, catalog number, length code, point diameter and material.

See ordering examples.

NOTE: If material is not specified, M2 will be provided.

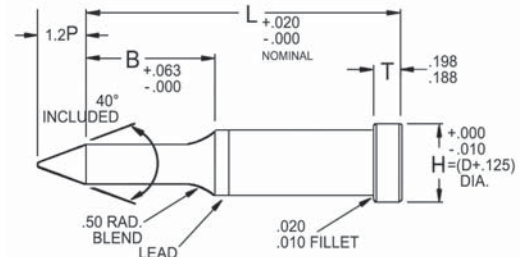
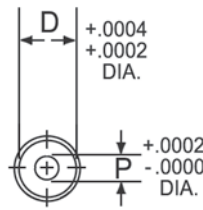

PPVA

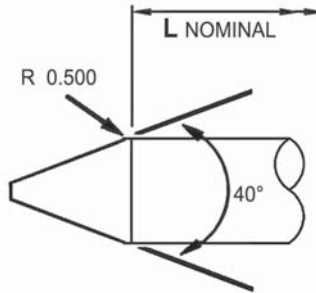

*Shaded areas represent standard products.
 Others available upon request.*

Shank Dia.	Catalog Number	Point Length	Point Range		Nominal Length L & Code										
			P Min.	P Max.	1.50	1.75	2.00	2.25	2.50	2.75	3.00	3.25	3.50	3.75	4.00
.3750	PPVA37	0.75	0.124	0.3750	1503	1753	2003	2253	2503	2753	3003	3253	3503	-	-
.4375	PPVA43		0.186	0.4375	1503	1753	2003	2253	2503	2753	3003	3253	3503	-	-
.5000	PPVA50		0.224	0.5000	1503	1753	2003	2253	2503	2753	3003	3253	3503	3753	4003
.6250	PPVA62		0.309	0.6250	1503	1753	2003	2253	2503	2753	3003	3253	3503	3753	4003
.7500	PPVA75		0.389	0.7500	1503	1753	2003	2253	2503	2753	3003	3253	3503	3753	4003
1.0000	PPVA100	0.484	1.0000	1503	1753	2003	2253	2503	2753	3003	3253	3503	3753	4003	
.3750	PPVA37	1.00	0.124	0.3750	-	1754	2004	2254	2504	2754	3004	3254	3504	-	-
.4375	PPVA43		0.186	0.4375	-	1754	2004	2254	2504	2754	3004	3254	3504	-	-
.5000	PPVA50		0.224	0.5000	-	1754	2004	2254	2504	2754	3004	3254	3504	3754	4004
.6250	PPVA62		0.309	0.6250	-	1754	2004	2254	2504	2754	3004	3254	3504	3754	4004
.7500	PPVA75		0.389	0.7500	-	1754	2004	2254	2504	2754	3004	3254	3504	3754	4004
1.0000	PPVA100	0.484	1.0000	-	1754	2004	2254	2504	2754	3004	3254	3504	3754	4004	
.3750	PPA37	1.25	0.124	0.3750	-	-	2005	2255	2505	2755	3005	3255	3505	-	-
.4375	PPVA43		0.186	0.4375	-	-	2005	2255	2505	2755	3005	3255	3505	-	-
.5000	PPVA50		0.224	0.5000	-	-	2005	2255	2505	2755	3005	3255	3505	3755	4005
.6250	PPVA62		0.309	0.6250	-	-	2005	2255	2505	2755	3005	3255	3505	3755	4005
.7500	PPVA75		0.389	0.7500	-	-	2005	2255	2505	2755	3005	3255	3505	3755	4005
1.0000	PPVA100	0.484	1.0000	-	-	2005	2255	2505	2755	3005	3255	3505	3755	4005	
.3750	PPVA37	150	0.124	0.3750	-	-	-	2256	2506	2756	3006	3256	3506	-	-
.4375	PPVA43		0.186	0.4375	-	-	-	2256	2506	2756	3006	3256	3506	-	-
.5000	PPVA50		0.224	0.5000	-	-	-	2256	2506	2756	3006	3256	3506	3756	4006
.6250	PPVA62		0.309	0.6250	-	-	-	2256	2506	2756	3006	3256	3506	3756	4006
.7500	PPVA75		0.389	0.7500	-	-	-	2256	2506	2756	3006	3256	3506	3756	4006
1.0000	PPVA100	0.484	1.0000	-	-	-	2256	2506	2756	3006	3256	3506	3756	4006	

EXAMPLE: 15 PPVA37 - 3003 P .125 PM4

Press Fit Die Buttons



Round

Concentricity: Point to Shank (P:D) .0003 T.I.R. (Max.)

How to order:

Please specify: Quantity, catalog number, length code, hole diameter and material.

See ordering examples.

NOTE: A2 or M2 material will be selected at our discretion, unless specified.

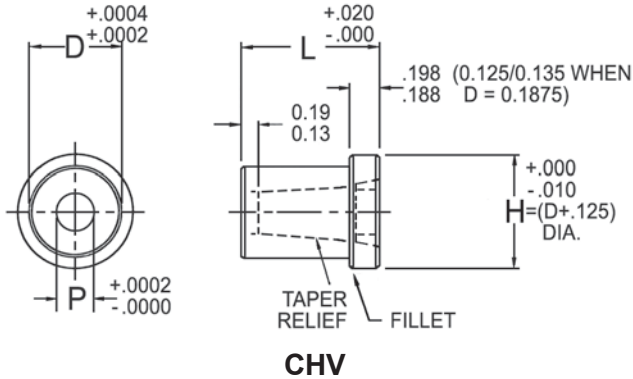

CHV

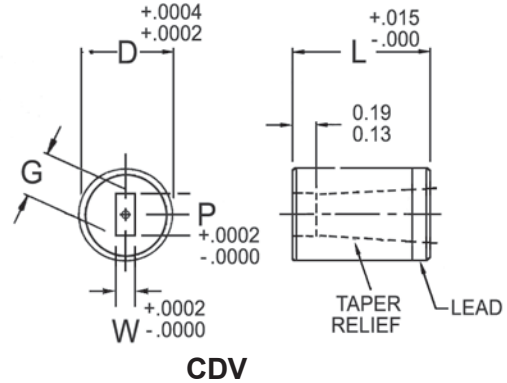

CDV



CHV ROUND (HEADED)



CDV ROUND (HEADLESS)

Shaded areas represent standard products.
Others available upon request.

Body Dia.	Catalog Number	Catalog Number	Hole Range		Overall Length L & Code								
					P Min.	P Max.	.0500	.0625	0.750	0.875	1.000	1.125	1.250
.1875	CHV18	CDV18	0.038	0.130	50	62	75	87	100	112	-	-	-
.2500	CHV25	CDV25	0.050	0.170	50	62	75	87	100	112	-	-	-
.3125	CHV31	CDV31	0.062	0.212	50	62	75	87	100	112	125	-	-
.3750	CHV37	CDV37	0.075	0.255	50	62	75	87	100	112	125	137	150
.4375	CHV43	CDV43	0.130	0.297	50	62	75	87	100	112	125	137	150
.5000	CHV50	CDV50	0.150	0.344	50	62	75	87	100	112	125	137	150
.6250	CHV62	CDV62	0.188	0.425	-	-	75	87	100	112	125	137	150
.7500	CHV75	CDV75	0.225	0.510	-	-	75	87	100	112	125	137	150
.8750	CHV87	CDV87	0.300	0.595	-	-	75	87	100	112	125	137	150
1.0000	CHV100	CDV100	0.400	0.680	-	-	75	87	100	112	125	137	150
1.2500	CHV125	CDV125	0.500	0.850	-	-	75	87	100	112	125	137	150
1.5000	CHV150	CDV150	0.600	1.050	-	-	75	87	100	112	125	137	150
1.7500	CHV175	CDV175	0.750	1.400	-	-	75	87	100	112	125	137	150
2.0000	CHV200	CDV200	0.875	1.600	-	-	75	87	100	112	125	137	150

EXAMPLE: 6 CHV75 - 125 P .230 M2

Oblong and Rectangle

Concentricity: Point to Shank (P:D) .0003 T.I.R. (Max.)
NOTE: Fillets and sharp corners on die buttons will be .007 Max.

How to order:

Please specify: Quantity, catalog number, length code, hole dimensions, material and if desired, Standard or Custom Locking Device.*

See ordering examples.

NOTE: A2 or M2 material will be selected at our discretion, unless specified.

$$\text{Rectangle: } G = \sqrt{W^2 + P^2}$$

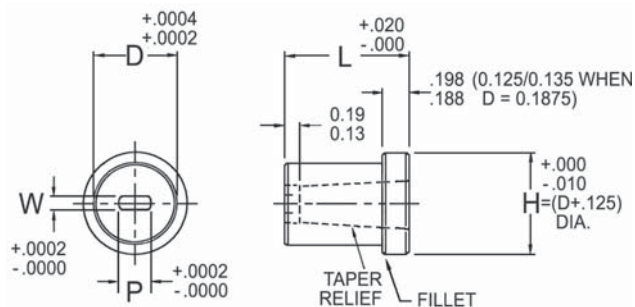

OHV

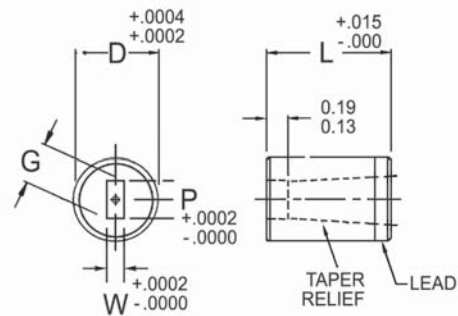

RDV

Shaded areas represent standard products.
 Others available upon request.

OHV OBLONG (HEADED)

ODV OBLONG (HEADLESS)

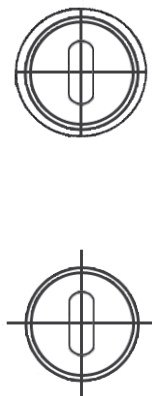

Body Dia.	Catalog Number	Catalog Number	Hole Range		Overall Length L & Code										
			P Max.	W Min.	.0500	.0625	0.750	0.875	1.000	1.125	1.250	1.375	1.500		
D	Headed	Headless													
.1875	OHV18	ODV18	0.130	0.050	50	62	75	87	100	112	-	-	-	-	-
.2500	OHV25	ODV25	0.170	0.050	50	62	75	87	100	112	-	-	-	-	-
.3125	OHV31	ODV31	0.212	0.050	50	62	75	87	100	112	125	-	-	-	-
.3750	OHV37	ODV37	0.255	0.050	50	62	75	87	100	112	125	137	150	-	-
.4375	OHV43	ODV43	0.297	0.075	50	62	75	87	100	112	125	137	150	-	-
.5000	OHV50	ODV50	0.344	0.075	50	62	75	87	100	112	125	137	150	-	-
.6250	OHV62	ODV62	0.425	0.075	-	-	75	87	100	112	125	137	150	-	-
.7500	OHV75	ODV75	0.510	0.075	-	-	75	87	100	112	125	137	150	-	-
.8750	OHV87	ODV87	0.595	0.075	-	-	75	87	100	112	125	137	150	-	-
1.0000	OHV100	ODV100	0.680	0.075	-	-	75	87	100	112	125	137	150	-	-
1.2500	OHV125	ODV125	0.850	0.075	-	-	75	87	100	112	125	137	150	-	-
1.5000	OHV150	ODV150	1.050	0.075	-	-	75	87	100	112	125	137	150	-	-
1.7500	OHV175	ODV175	1.400	0.130	-	-	75	87	100	112	125	137	150	-	-
2.0000	OHV200	ODV200	1.600	0.130	-	-	75	87	100	112	125	137	150	-	-

EXAMPLE: 1?????

RHV RECTANGLE, INCLUDES SQUARE (HEADED)

RDV RECTANGLE, INCLUDES SQUARE (HEADED)

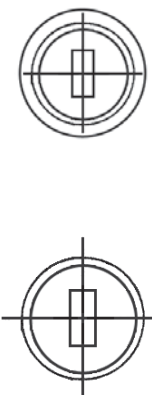

Body Dia.	Catalog Number	Catalog Number	Hole Range		Overall Length L & Code										
			G Max.	W Min.	.0500	.0625	0.750	0.875	1.000	1.125	1.250	1.375	1.500		
D	Headed	Headless													
.1875	RHV18	RDV18	0.130	0.050	50	62	75	87	100	112	-	-	-	-	-
.2500	RHV25	RDV25	0.170	0.050	50	62	75	87	100	112	-	-	-	-	-
.3125	RHV31	RDV31	0.212	0.050	50	62	75	87	100	112	125	-	-	-	-
.3750	RHV37	RDV37	0.255	0.050	50	62	75	87	100	112	125	137	150	-	-
.4375	RHV43	RDV43	0.297	0.075	50	62	75	87	100	112	125	137	150	-	-
.5000	RHV50	RDV50	0.344	0.075	50	62	75	87	100	112	125	137	150	-	-
.6250	RHV62	RDV62	0.425	0.075	-	-	75	87	100	112	125	137	150	-	-
.7500	RHV75	RDV75	0.510	0.075	-	-	75	87	100	112	125	137	150	-	-
.8750	RHV87	RDV87	0.595	0.075	-	-	75	87	100	112	125	137	150	-	-
1.0000	RHV100	RDV100	0.680	0.075	-	-	75	87	100	112	125	137	150	-	-
1.2500	RHV125	RDV125	0.850	0.075	-	-	75	87	100	112	125	137	150	-	-
1.5000	RHV150	RDV150	1.050	0.075	-	-	75	87	100	112	125	137	150	-	-
1.7500	RHV175	RDV175	1.400	0.130	-	-	75	87	100	112	125	137	150	-	-
2.0000	RHV200	RDV200	1.600	0.130	-	-	75	87	100	112	125	137	150	-	-

EXAMPLE: 10 OHV50 - 75 P .205 W .133 M2

* Refer to page 13 for Locking Device information.

Ejector Punch Blanks



Blank and Straight Punches

Concentricity: Point to Shank (P:D) .0003 T.I.R. (Max.)

How to order:

Please specify:

(BKV) Quantity, catalog number, length code, and material.

(XKV) Quantity, catalog number, length code, point diameter and material.

See ordering examples.

NOTE: If material is not specified, M2 will be provided.

BKV

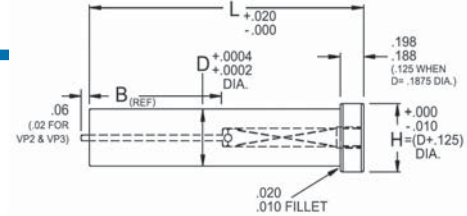

XKV

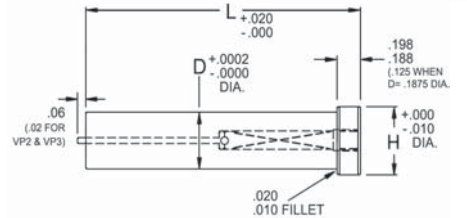

Shaded areas represent standard products.
Others available upon request.

BKV (PUNCH BLANK)



Shank Dia.	Catalog Number	Point Length	Overall Length L & Code												Ejector Group		
			B	1.25	1.50	1.75	2.00	2.25	2.50	2.75	3.00	3.25	3.50	3.75		4.00	
.1875	BKV18	0.50		1252	1502	1752	2002	2252	2502							VP2	
.2500	BKV25		1252	1502	1752	2002	2252	2502	2752	3002						VP3	
.3125	BKV31		1252	1502	1752	2002	2252	2502	2752	3002						VP4	
.3750	BKV37		1252	1502	1752	2002	2252	2502	2752	3002	3252	3502				VP6	
.1875	BKV18	0.75			1503	1753	2003	2253	2503							VP2	
.2500	BKV25				1503	1753	2003	2253	2503	2753	3003					VP3	
.3125	BKV31				1503	1753	2003	2253	2503	2753	3003					VP4	
.3750	BKV37				1503	1753	2003	2253	2503	2753	3003	3253	3503			VP6	
.4375	BKV43				1503	1753	2003	2253	2503	2753	3003	3253	3503			VP6	
.5000	BLV50				1503	1753	2003	2253	2503	2753	3003	3253	3503	3753	4003	VP6	
.6250	BKV62				1503	1753	2003	2253	2503	2753	3003	3253	3503	3753	4003	VP9	
.7500	BKV75				1503	1753	2003	2253	2503	2753	3003	3253	3503	3753	4003	VP9	
1.0000	BKV100				1503	1753	2003	2253	2503	2753	3003	3253	3503	3753	4003	VP9	
.1875	BKV18		1.00				1754	2004	2254	2504							VP2
.2500	BKV25					1754	2004	2254	2504	2754	3004					VP3	
.3125	BKV31					1754	2004	2254	2504	2754	3004					VP4	
.3750	BKV37					1754	2004	2254	2504	2754	3004	3254	3504			VP6	
.4375	BKV43					1754	2004	2254	2504	2754	3004	3254	3504			VP6	
.5000	BKV50					1754	2004	2254	2504	2754	3004	3254	3504	3754	4004	VP6	
.6250	BKV62					1754	2004	2254	2504	2754	3004	3254	3504	3754	4004	VP9	
.7500	BKV75					1754	2004	2254	2504	2754	3004	3254	3504	3754	4004	VP9	
1.0000	BKV100					1754	2004	2254	2504	2754	3004	3254	3504	3754	4004	VP9	
.2500	BKV25	1.25						2005	2255	2505	2755	3005					VP3
.3125	BKV31						2005	2255	2505	2755	3005					VP4	
.3750	BKV37						2005	2255	2505	2755	3005	3255	3505			VP6	
.4375	BKV43						2005	2255	2505	2755	3005	3255	3505			VP6	
.5000	BKV50						2005	2255	2505	2755	3005	3255	3505	3755	4005	VP6	
.6250	BKV62						2005	2255	2505	2755	3005	3255	3505	3755	4005	VP9	
.7500	BKV75						2005	2255	2505	2755	3005	3255	3505	3755	4005	VP9	
1.0000	BKV100						2005	2255	2505	2755	3005	3255	3505	3755	4005	VP9	
.3125	BKV31		1.50						2256	2506	2756	3006					VP4
.3750	BKV37									2256	2506	2756	3006	3256	3506		
.4375	BKV43								2256	2506	2756	3006	3256	3506			VP6
.5000	BKV50								2256	2506	2756	3006	3256	3506	3756	4006	VP6
.6250	BKV62								2256	2506	2756	3006	3256	3506	3756	4006	VP9
.7500	BKV75								2256	2506	2756	3006	3256	3506	3756	4006	VP9
1.0000	BKV100								2256	2506	2756	3006	3256	3506	3756	4006	VP9

EXAMPLE: 5 BKV25 - 2004 PM4

Shaded areas represent standard products.
Others available upon request.

BKV (PUNCH BLANK)



Catalog Number	Diameter Range		H	Overall Length L & Code												Ejector Group
	D Min.	D Max.		1.25	1.50	1.75	2.00	2.25	2.50	2.75	3.00	3.25	3.50	3.75	4.00	
PPV12	0.1876	0.2500	0.375	125	150	175	200	225	250	275	300					VP3
PPV18	0.2501	0.3125	0.437	125	150	175	200	225	250	275	300					VP4
PPV25	0.3126	0.3750	0.500	125	150	175	200	225	250	275	300	325	350			VP6
PPV31	0.3751	0.4375	0.562	125	150	175	200	225	250	275	300	325	350			VP6
PPV37	0.4376	0.5000	0.625	125	150	175	200	225	250	275	300	325	350	375	400	VP6
PPV12	0.5001	0.6250	0.750	125	150	175	200	225	250	275	300	325	350	375	400	VP9

EXAMPLE: 5 XKV25 - 200 D .249 PM4

* Refer to the Miscellaneous section for ejector data.

Light Duty

How to order:

Please specify:

(BPV) Quantity, catalog number, length code, and material.

(XPV) Quantity, catalog number, length code, point diameter and material.

See ordering examples.

NOTE: If material is not specified, M2 will be provided.

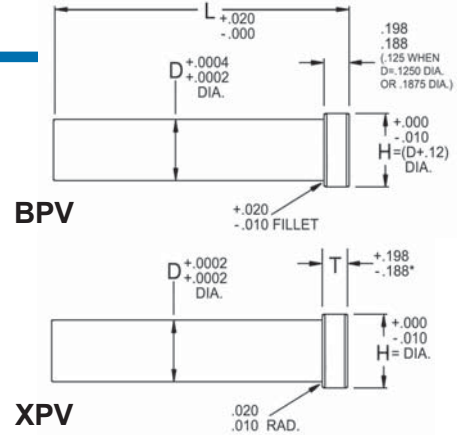

Shaded areas represent standard products.
Others available upon request.

BPV (PUNCH BLANK)



Shank Dia.	Catalog Number	Overall Length L & Code											
		D	1.25	1.50	1.75	2.00	2.25	2.50	2.75	3.00	3.25	3.50	3.75
.1250	BPV12	125	150	175	200	225	250	275	300	325	350	375	400
.1875	BPV18	125	150	175	200	225	250	275	300	325	350	375	400
.2500	BPV25	125	150	175	200	225	250	275	300	325	350	375	400
.3125	BPV31	125	150	175	200	225	250	275	300	325	350	375	400
.3750	BPV37	125	150	175	200	225	250	275	300	325	350	375	400
.4375	BPV43	125	150	175	200	225	250	275	300	325	350	375	400
.5000	BPV50	125	150	175	200	225	250	275	300	325	350	375	400
.6250	BPV62	125	150	175	200	225	250	275	300	325	350	375	400
.7500	BPV75	125	150	175	200	225	250	275	300	325	350	375	400
1.0000	BPV100	125	150	175	200	225	250	275	300	325	350	375	400

EXAMPLE: 5 BPV25 - 200 PM4

XPV (STRAIGHT PUNCH)



Catalog Number	Diameter Range		H	Overall Length L & Code											
	D Min.	D Max.		1.25	1.50	1.75	2.00	2.25	2.50	2.75	3.00	3.25	3.50	3.75	4.00
XPV12	0.0620	0.1250	0.250	125	150	175	200	225	250	275	300	325	350	375	400
XPV18	0.1251	0.1875	0.312	125	150	175	200	225	250	275	300	325	350	375	400
XPV25	0.1876	0.2500	0.375	125	150	175	200	225	250	275	300	325	350	375	400
XPV31	0.2501	0.3125	0.437	125	150	175	200	225	250	275	300	325	350	375	400
XPV37	0.3126	0.3750	0.500	125	150	175	200	225	250	275	300	325	350	375	400
XPV43	0.3751	0.4375	0.562	125	150	175	200	225	250	275	300	325	350	375	400
XPV50	0.4376	0.5000	0.625	125	150	175	200	225	250	275	300	325	350	375	400
XPV62	0.5001	0.6250	0.750	125	150	175	200	225	250	275	300	325	350	375	400

EXAMPLE: 5 XPV25 - 200 D .2015 PM4

Stripper Guides



Round, Oblong, Rectangle, Square

Concentricity: Point to Shank (P:D)
.0003 T.I.R. (Max.)

How to order:

Please specify: Quantity, catalog number, overall length, point dimensions and material.

See ordering examples.

NOTE: If material is not specified, M2 will be provided.

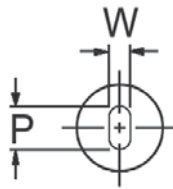
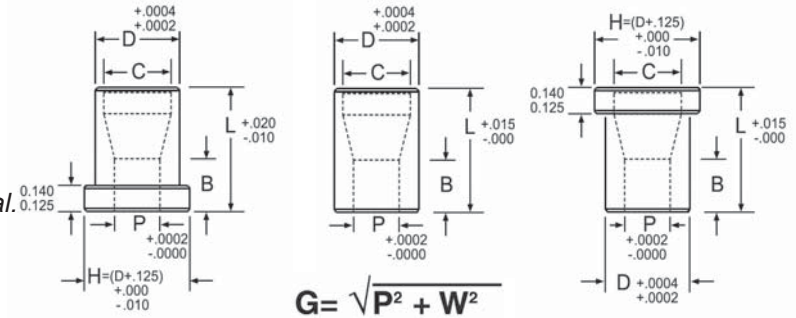

Tolerance
(P, W) +.0002
-.0000

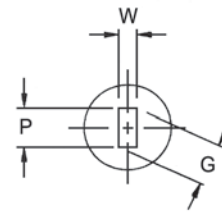

Shaded areas represent standard products.
Others available upon request.

GV (HEADLESS)

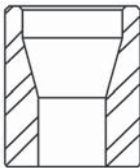

Body Dia.	Catalog Numbers			Hole Range				Overall Length L & Code				Lead In Dia.
				Rounds		Shapes		0.3125	0.375	0.500	0.625	
D	Round	Oblong	Rect/Sq	P Min.	P Max.	P/G Max.	W Min.					
.1875	CGV18	OGV18	RGV18	0.062	0.130	0.130	0.050	31	37	50	-	0.141
.2500	CGV25	OGV25	RGV25	0.062	0.170	0.170	0.050	-	37	50	62	0.201
.3125	CGV31	OGV31	RGV31	0.093	0.212	0.212	0.050	-	37	50	62	0.261
.3750	CGV37	OGV37	RGV37	0.125	0.255	0.255	0.050	-	37	50	62	0.323
.4375	CGV43	OGV43	RGV43	0.187	0.297	0.297	0.075	-	37	50	62	0.386
.5000	CGV50	OGV50	RGV50	0.212	0.344	0.344	0.075	-	-	50	62	0.488
.6250	CGV62	OGV62	RGV62	0.293	0.426	0.426	0.075	-	-	-	62	-

EXAMPLE: 5_GV25 - 37 P .1357 A2

UV (HEAD DOWN)

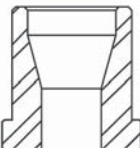

Body Dia.	Catalog Numbers			Hole Range				Overall Length L & Code				Lead In Dia.
				Rounds		Shapes		0.3125	0.375	0.500	0.625	
D	Round	Oblong	Rect/Sq	P Min.	P Max.	P/G Max.	W Min.					
.1875	CUV18	OUV18	RUV18	0.062	0.130	0.130	0.050	31	37	50	-	0.141
.2500	CUV25	OUV25	RUV25	0.062	0.170	0.170	0.050	-	37	50	62	0.201
.3125	CUV31	OUV31	RUV31	0.093	0.212	0.212	0.050	-	37	50	62	0.261
.3750	CUV37	OUV37	RUV37	0.125	0.255	0.255	0.050	-	37	50	62	0.323
.4375	CUV43	OUV43	RUV43	0.187	0.297	0.297	0.075	-	37	50	62	0.386
.5000	CUV50	OUV50	RUV50	0.212	0.344	0.344	0.075	-	-	50	62	0.488
.6250	CUV62	OUV62	RUV62	0.293	0.426	0.426	0.075	-	-	-	62	-

EXAMPLE: 5_UV25 - 37 P .1357 A2

TV (HEAD UP)

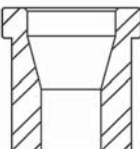

Body Dia.	Catalog Numbers			Hole Range				Overall Length L & Code				Lead In Dia.
				Rounds		Shapes		0.3125	0.375	0.500	0.625	
D	Round	Oblong	Rect/Sq	P Min.	P Max.	P/G Max.	W Min.					
.1875	CTV18	OTV18	RTV18	0.062	0.130	0.130	0.050	31	37	50	-	0.141
.2500	CTV25	OTV25	RTV25	0.062	0.170	0.170	0.050	-	37	50	62	0.201
.3125	CTV31	OTV31	RTV31	0.093	0.212	0.212	0.050	-	37	50	62	0.261
.3750	CTV37	OTV37	RTV37	0.125	0.255	0.255	0.050	-	37	50	62	0.323
.4375	CTV43	OTV43	RTV43	0.187	0.297	0.297	0.075	-	37	50	62	0.386
.5000	CTV50	OTV50	RTV50	0.212	0.344	0.344	0.075	-	-	50	62	0.488
.6250	CTV62	OTV62	RTV62	0.293	0.426	0.426	0.075	-	-	-	62	-

EXAMPLE: 5_TV25 - 37 P .1357 A2

* Refer to page 13 for Locking Device information.

Custom and Standard Locations

How to order Custom Location:

Please specify: Type, angle (Y) and depth (M).

Example:

OKM37 L 2.25 P .313 W .188 M2 SKF Y 45° M .156

How to order Standard Location:

Please specify: Type.

Example:

OKM37 L 2.25 P .313 W .188 M2 SKF

CUSTOM

Shape orientation, key flat and dowel slot depth to be specified by the customer.

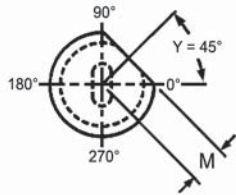

NON-STANDARD LOCATION OR DEPTH



SINGLE KEY FLAT (SKF)

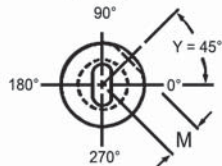

NON-STANDARD LOCATION OR DEPTH

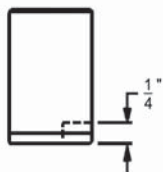

NOTE:
PUNCHES VIEWED THROUGH THE SHANK

STANDARD

Shape orientation is established by the polar positions shown below, at 0°. Standard key flat and dowel slot depth is as shown.

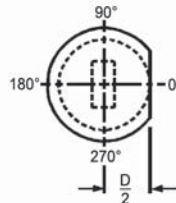

SINGLE KEY FLAT (SKF)

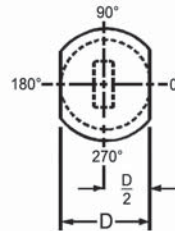
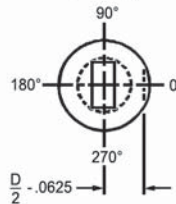

DOUBLE KEY FLAT (DKF)

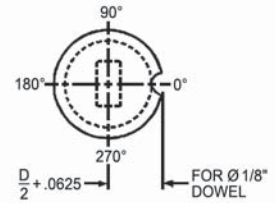
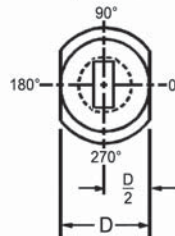

DOWEL SLOT (DS)

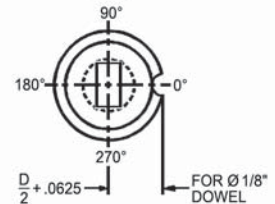

NOTE:
PUNCHES VIEWED THROUGH THE SHANK

Punchrite®

Quality you can rely on



Anchor Danly

CALL: 800-232-6592

FAX: 800-432-6594

www.anchor danly.com
punchproducts@anchor danly.com